

# 1/32 DIN TEMPERATURE INDICATOR & CONTROLLER

## CONCISE PRODUCT MANUAL (59227-9)

Note: This symbol indicates that feature / parameter is not available on Indicator Units

### FRONT PANEL



Green: OFF - PV < SP  
ON - PV = SP  
Flashing - PV > SP

Yellow: OFF - Normal Operation  
ON - Control Set-Up Mode  
Flashing - Configuration Mode

Red: Flashing - Alarm(s) active

### NORMAL OPERATION (Yellow LED OFF)

NOTE: Set all Configuration Mode and Setup Mode parameters as desired before starting normal operations.

Use Scroll key to step through parameter display sequence as follows:

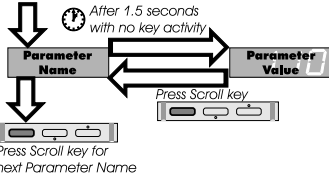

Use Up and Down keys to adjust displayed value.

The parameter display sequence is as follows:

Legend	Meaning	Adjustment Range	Default
<b>PrO</b>	Process Variable: Read Only display - not adjustable	N/A	N/A
<b>ALSt</b>	Alarm Status: Included in sequence only if two alarms are configured and at least one is active.	N/A	N/A
<b>SP</b>	Setpoint Selection: Included in the sequence only if Dual Setpoint operation is configured.	1 or 2	1
<b>SP1</b>	Setpoint (1) value: adjustable only if setpoint adjustment is enabled (see <b>CONTROL SETUP</b> ).	Input Range Min. to Input Range Max.	Input Range Min.
<b>SP2</b>	Setpoint 2 value: included in the sequence only if Dual Setpoint operation is configured; adjustable only if setpoint adjustment is enabled (see <b>CONTROL SETUP</b> ).	Input Range Min. to Input Range Max.	Input Range Min.
<b>AL1</b>	Alarm (1) value: Included in the sequence only if access to the alarm display is enabled (see <b>CONTROL SETUP</b> ) and an alarm is configured.	Process High: Input Range Min. - Input Range Max. Process Low: Input Range Min. - Input Range Max. Deviation (high or low): -(input span) - +(input span) Band: 1 LSD - input span	Process High alarm, Input Range Max.
<b>AL2</b>	Alarm 2 value: Included in the sequence only if access to the alarm display is enabled (see <b>CONTROL SETUP</b> ) and two alarms are configured.	Process High: Input Range Min. - Input Range Max. Process Low: Input Range Min. - Input Range Max. Deviation (high or low): -(input span) - +(input span) Band: 1 LSD - input span	Process Low alarm, Input Range Min.

### Easy Tune

If the Controller is configured for Easy Tune operation, all tuning is performed automatically, at each power up.

### Manual Tuning with Pre-Tune

If the Controller is configured for manual tuning, a one-shot Pre-Tune can be used to optimise system at any time.

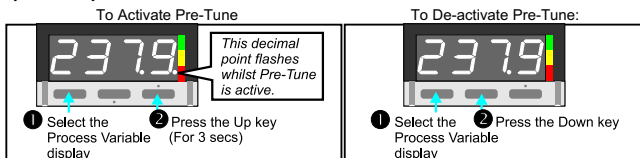

NOTE: Pre-Tune is a single-shot operation and will automatically dis-engage itself after completion of its routine. Pre-Tune will not be activated; (a) if the process variable is within 5% of input span from the setpoint, (b) if the unit is configured for on/off control or (c) if Easy Tune is selected.

### CONTROL SET-UP MODE (Yellow LED ON)

Note: Set all Configuration Mode parameters as desired before adjusting Set Up Mode parameters

### Entry/Exit

Press the Up and Down keys simultaneously for more than three seconds.

### Set Up Mode Parameter Sequence

Parameters are selected and adjusted as described in NORMAL OPERATION.

Legend	Parameter	Adjustment Range	Default
<b>SP1</b>	Setpoint (1) value	Input Range Min. to Input Range Max.	Input Range Min.
<b>SP2</b>	Setpoint 2 value - appears only if Dual Setpoint operation is configured	Input Range Min. to Input Range Max.	Input Range Min.
<b>Pb</b>	Proportional Band value (Only with Manual Tune & PID control)	1.0% to 999.9% in 0.1% increments.	10.0%
<b>RES</b>	Reset (Integral) value (Only with Manual Tune & PID control)	1 second to 99 minutes 59 seconds and OFF (greater than 99 minutes 59 seconds)	5 minutes
<b>RD</b>	Rate (Derivative) value (Only with Manual Tune & PID control)	0 (OFF) to 99 minutes 59 seconds	1 minute 15 seconds
<b>bIAS</b>	Bias (Manual Reset) value (Only with Manual Tune & PID control)	0% to 100%	25%
<b>HYSt</b>	ON/OFF Hysteresis value (Only with On/Off control)	0.1% to 10.0% of input span	0.5% of input span
<b>AL1</b>	Alarm 1 value	Process High: Input Range Min. - Input Range Max. Process Low: Input Range Min. - Input Range Max. Deviation (high or low): -(input span) - +(input span) Band: 1 LSD - input span	Process High alarm, Input Range Max.
<b>AL2</b>	Alarm 2 value	Process High: Input Range Min. - Input Range Max. Process Low: Input Range Min. - Input Range Max. Deviation (high or low): -(input span) - +(input span) Band: 1 LSD - input span	Process Low alarm, Input Range Min.
<b>FILT</b>	Input Filter Time Constant value	0 seconds to 100 seconds	2 seconds
<b>OFFS</b>	Input Offset value	±input span.	0
<b>CT</b>	Output Cycle Time value	0.5 (SSR drive only), 1, 2, 4, 8, 16, 32, 64, 128, 256 and 512 seconds	16 seconds
<b>SPL</b>	Setpoint Lock	<b>OFF</b> Setpoint adjustment enabled in Normal Operation. <b>ON</b> Setpoint adjustment disabled in Normal Operation.	<b>OFF</b>
<b>REn</b>	Disable/enable access to Alarm Value in Normal Operation	<b>EnAb</b> Display/adjustment enabled in Normal Operation. <b>DiSA</b> Display/adjustment disabled in Normal Operation.	<b>EnAb</b>

### INSTALLATION

**CAUTION:** This equipment is intended for field installation within the enclosure of another product. Installation and configuration should be performed only by personnel who are technically-competent & authorised to do so. Local Regulations regarding electrical installation & safety must be observed.

### Panel Mounting

The mounting panel must be rigid and may be up to 6.0mm (0.25 inches) thick. The cut-out required for the Controller is shown on the right. Controllers may be mounted side-by-side in a multiple installation for which the cut-out width (for n Controllers) is (48n-4)mm or (1.89n-0.16) inches. For panel-mounting see below.

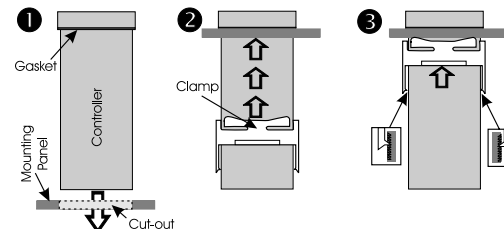
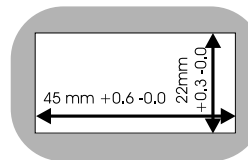

**CAUTION:** Do not remove the front panel gasket from the Controller, as this may cause inadequate clamping of the Controller to the mounting panel. Ensure that this gasket is not distorted and that the Controller is positioned squarely against the mounting panel. Apply pressure to the front panel bezel only.

### Rear Terminals

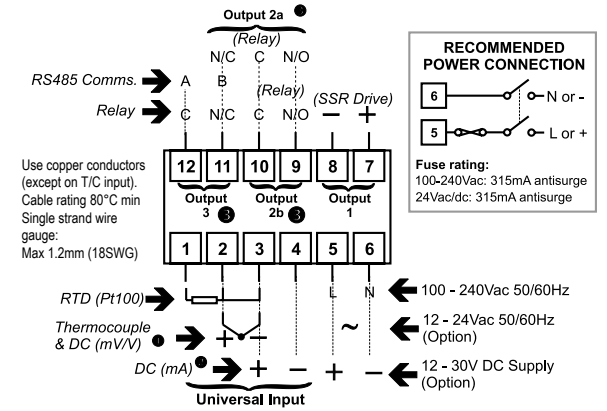

- The DC (mV) input may serve as a DC (V) input using an external attenuator.
- If DC (mA) input is used, an external link of <math><0.1\Omega</math> must be connected to Terminals 2 & 4.
- Output 2a is available only if Output 3 is not fitted.

### Output Usage

Output	Control Output	Alarm 1 Output	Alarm 2 Output	Serial Comms.
Output 1	*	*		
Output 2a	*	*		
Output 2b	*	*		
Output 3			*	*

### CONFIGURATION MODE

### Entry

Hold down the Scroll and Up keys simultaneously until the display starts to flash, then release those keys and press the Down key.

### Configuration Mode Parameter Sequence

Parameters are selected and adjusted as described in NORMAL OPERATION.

Legend	Parameter	Adjustment Range	Default
<b>SEnS</b>	Sensor Select: Selects input sensor type, resolution and input units (°F or °C) by means of a code number.	See <b>Sensor Selection Codes</b> below.	100 - Thermocouple "J" (-200°C to 1200°C)
<b>rLO</b>	Input Range Minimum: Defines minimum value of input range.	Thermocouple/RTD: Range Minimum value for selected sensor (See <b>Sensor Selection Codes</b> below) to 100 LSDs less than current <b>Input Range Maximum</b> setting. DC: -1999 to 9999 with decimal point position according to <b>Input Range Decimal Point</b> setting	Thermocouple/RTD: Input Range Minimum. DC: 0
<b>rHi</b>	Input Range Maximum: Defines maximum value of input range.	Thermocouple/RTD: 100 LSDs greater than current <b>Input Range Minimum</b> setting to <b>Range Maximum</b> value for selected sensor (See <b>Sensor Selection Codes</b> below). DC: -1999 to 9999 with decimal point position according to <b>Input Range Decimal Point</b> setting	Thermocouple/RTD: Input Range Maximum. DC: 1000
<b>rPnt</b>	Input Range Decimal Point Position: For DC inputs only; determines decimal point position.	0 (xxxx), 1 (xxx.x) 2 (xx.xx) or 3 (x.xxx)	0 (xxxx)
<b>OUtS</b>	Output Selection: Links outputs to required functions by a 3-digit code (see <b>Output Selection Code</b> ).	See <b>Output Selection Code</b> .	N/A
<b>Addr</b>	Communications Address: Defines unique communications address for Controller. Appears only if the <b>Communications Option</b> is configured and fitted.	1 to 128	1
<b>BAUD</b>	Communications Baud Rate: selects Baud rate for serial communications. Appears only if the <b>Communications Option</b> is configured and fitted.	12 1200    24 2400 48 4800    96 9600	4800
<b>PAR</b>	Communications Parity: defines parity for serial communications. Appears only if the <b>Communications Option</b> is configured and fitted.	odd Odd    even Even none None	None

Legend	Parameter	Adjustment Range	Default
	Single/Dual Setpoint Select: Selects single setpoint operation or dual setpoint operation.	1 Single 2 Dual	Single setpoint operation
	Alarm 1 Type	<b>PHd</b> Process High, direct-acting <b>PLd</b> Process Low, direct-acting <b>dEd</b> Deviation, direct-acting <b>bEd</b> Band, direct-acting <b>PHr</b> Process High, reverse-acting <b>PLr</b> Process Low, reverse-acting <b>dEr</b> Deviation, reverse-acting <b>bEr</b> Band, reverse-acting	Process High, direct-acting
	Alarm 2 Type. <i>Appears only if Output 3 is configured and fitted.</i>	As for Alarm 1 Type.	Process Low, direct-acting
	Control Select: defines control action and algorithm	<b>r-P</b> PID, reverse-acting <b>d-P</b> PID, direct-acting <b>r-o</b> ON/OFF, reverse-acting <b>d-o</b> ON/OFF, direct-acting	PID, reverse-acting
	Tuning Select: Selects Manual Tuning or Hands-Off tuning (Easy Tune). <i>Appears only if PID control is selected (see above).</i>	<b>EASY</b> Easy Tune <b>MAN</b> Manual Tuning (with Pre-Tune)	Easy Tune

### Sensor Selection Codes

Input Type	Code	Range Minimum	Range Maximum
<b>Thermocouple</b>			
Type J	100 (°C)	-200°C	1200°C
	101 (°F)	-32°F	2191°F
	110 (°C)	-128.0°C	537.0°C
	111 (°F)	-198.4°F	998.5°F
Type T	200 (°C)	-240°C	401°C
	201 (°F)	-400°F	753°F
	210 (°C)	-128.0°C	400.6°C
	211 (°F)	-198.4°F	753.0°F
Type K	300 (°C)	-240°C	1371°C
	301 (°F)	-400°F	2499°F
	310 (°C)	-128.0°C	536.7°C
	311 (°F)	-198.4°F	998.0°F
Type N	400 (°C)	0°C	1399°C
	401 (°F)	32°F	2550°F
Type B	500 (°C)	100°C	1824°C
	501 (°F)	211°F	3315°F
Type R	600 (°C)	0°C	1759°C
	601 (°F)	32°F	3198°F
Type S	700 (°C)	0°C	1770°C
	701 (°F)	32°F	3217°F
<b>RTD</b>			
PT100	800 (°C)	-199°C	802°C
	801 (°F)	-327°F	1475°F
	810 (°C)	-127.9°C	537.0°C
	811 (°F)	-198.3°F	998.5°F
<b>DC Linear</b>			
0 - 20mA	900	-1999	9999
4 - 20mA	1000	-1999	9999
0 - 50mV	2000	-1999	9999
10 - 50mV	3000	-1999	9999

### Output Selection Code

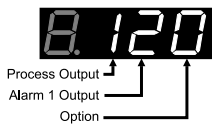

Process Output		Alarm 1 Output		Option	
Code	Meaning	Code	Meaning	Code	Meaning
0	Not fitted	0	Not fitted	0	Not fitted
1	Enables Output 2 Relay as control output (if fitted)	1	Enables Output 2 Relay (a or b) as Alarm 1 (if fitted)	1	Enables Second Relay output as Alarm 2 (if fitted)
2	Enables Output 1 SSR Drive as control output (if fitted)	2	Enables Output 1 SSR Drive as Alarm 1 (if fitted)	2	Enables Comms. Option (MODBUS) (if fitted)

### Exit

Display any parameter name then hold down the Up and Down keys for three seconds.

**NOTE:** An automatic exit is made if there is no key activity for five minutes.

## MODBUS COMMUNICATIONS

### Functions Supported

The following MODBUS functions are supported, (JBUS names - where such an equivalence exists - in italics):

- Read Coil Status (*Read n Bits*) - **01/02**
- Read Holding Registers (*Read n Words*) - **03/04**
- Force Single Coil (*Write 1 Bit*) - **05**
- Preset Single Register (*Write 1 Word*) - **06**
- Loopback Diagnostic Test - **08**
- Preset Multiple Registers (*Write n Words*) - **16**

The instrument will identify itself in reply to a Read Holding Registers message which enquires the values of parameter numbers 121 and 122.

Bit Parameters		
Parameter	Number	Notes
Reserved	1 - 3	
Pre-Tune*	4	To enable Pre-Tune, write a non-zero value; to disable Pre-Tune, write zero. Enable Pre-Tune will fail if the process variable is within 5% of input span from the setpoint. This failure will not be signalled by communications.
Alarm 1 Status	5	Read Only
Alarm 2 Status	6	Read Only
Reserved	7 - 16	

Word Parameters		
Parameter	Number	Notes
Process Variable value	1	Read Only
Current Setpoint value	2	Read Only
Output Power	3	Read Only
Deviation	4	Read Only
Proportional Band	5	
Reset	6	
Rate	7	
Bias	8	
ON/OFF Differential	9	
Output Cycle Time	10	
Input Filter Time Constant	11	
Alarm 1 value	12	
Alarm 2 value	13	
Selected Setpoint (1 or 2)	14	
Setpoint 1 value	15	
Setpoint 2 value	16	
Process Variable Offset	17	
Range Decimal Point Position	18	
Manufacturer ID	121	Read Only - 231 (representing "W1")
Equipment ID	122	Read Only - number 2300

## MESSAGES & ERROR INDICATONS

### Default Indication

This display (all decimal points ON) indicates that all Set Up parameters have been set to their default values (caused by a change to one or more of the critical Configuration Mode parameters). To clear this display, alter one of the Set Up Mode parameters.



### Sensor Break Indication

This display indicates that a break has been detected in process variable input sensor or wiring. Alternatively, the Sensor Select parameter may be set incorrectly for the signal type applied.



### Over-Range Indication

This display indicates that the input signal is greater than the Input Range Maximum. Alternatively, the Sensor Select parameter may be set incorrectly for the signal type applied.



### Under-Range Indication

This display indicates that the input signal is less than the Input Range Minimum. Alternatively, the Sensor Select parameter may be set incorrectly for the signal type applied.

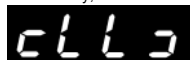

## SPECIFICATION

### UNIVERSAL INPUT

Input impedance: >1MΩ resistive except for DC mA (4.7Ω).  
Isolation: Isolated from all outputs (except SSR) Drive at 240V AC.

### OUTPUTS

#### Relay (Output 2 and Output 3)

Contact Type/Rating: Output 2a is Single Pole Double Throw (SPDT), Output 2b & Output 3 are Single Pole Single Throw (SPST); 2A resistive @ 120/240V AC.  
Isolated from all inputs / outputs

Lifetime: >500,000 operations at rated voltage/current.

#### SSR Drive/TTL (Output 1)

Drive Capability: 0 to 10V nominal into 500Ω minimum (20mA maximum).

Isolation: Not isolated from input.

### OPERATING CONDITIONS FOR INDOOR USE

Ambient Temperature (Operating): 0°C to 55°C.

Ambient Temperature (Storage): -20°C to +80°C.

Relative Humidity: 20% to 95% non-condensing.

Supply Voltage: 100 - 240Vac 50/60Hz (standard) 7.5VA

12 - 24Vac (option) 7.5VA or

12 - 30Vdc (option) 5W

### ENVIRONMENTAL

Approvals: CE, UL, & cUL.

EMC Immunity: EN61326-1:2013 Table 2

EN61326-1:2013 Class A

EMC Emission: This is a class A product. In a domestic environment this product may cause radio interference in which case the user may be required to take adequate measures.

Safety Considerations: UL61010-1 Edition 3 & EN61010 version 2010

Front Panel Sealing: IP66

### PHYSICAL

Dimensions: Depth (behind panel) - 100mm

Width (front panel) - 49mm

Height (front panel) - 25mm

Weight: 0.21kg maximum

WARNING: This product can expose you to chemicals including arsenic, which is known to the State of California to cause cancer. For more information go to [www.P65Warnings.ca.gov](http://www.P65Warnings.ca.gov)

## SAFETY AND WARNING SYMBOLS



Risk of electric shock.



Caution, refer to the manual.



Alternating or direct current could be present.



Equipment protected through-out by double insulation.